

**NV Series: 4 - 6W DC/DC Converters**  
**9-36V, 18-36V, 36-72V & 16-75V Inputs**  
**3.3V, 5.0V, 12V, 15V,  $\pm 5.0V$ ,  $\pm 12V$ ,  $\pm 15V$  &  $\pm 24V$  Outputs**



### Applications

- Distributed power architectures
- Telecommunications equipment
- LAN/WAN applications
- Data processing

### Features

- Single board design
- 8.5 mm height profile
- Excellent co-planarity
- Input/output isolation: 1500 Vdc
- Low conducted and radiated EMI
- Output overcurrent protection
- Parallel and series connection providing flexible output voltages and power
- Full rated output power at 71°C with convection cooling
- Operating temperature to 110°C
- UL, CSA and EN/IEC60950 (3<sup>rd</sup> ed.) approved

### Description

The NV series of converters are low profile, single and dual outputs, DC/DC converters intended for SMT placement and reflow soldering. The product provides on-board conversion of a wide range of standard telecom and datacom input voltages to isolated low output voltages. Proprietary patented manufacturing process with full process automation ensures optimal product quality in an extremely small footprint.

Selection Chart – Single output						
Model	Input voltage, Vdc	Input current, max, Adc	Output voltage, Vdc (Vo)	Output rated current, Adc (Io.Max)	Output ripple and noise, mVp-p	Efficiency, %
NVS01YG-M6	18-36	0.27	5.0	1.0	50	82
NVS0.5YH-M6	18-36	0.33	12	0.5	95	83
NVS0.4YJ-M6	18-36	0.33	15	0.4	120	84
NVS01ZE-M6	36-75	0.17	5.0	1.0	50	82
NVS0.5ZH-M6	36-75	0.17	12	0.5	95	82
NVS0.4ZJ-M6	36-75	0.17	15	0.4	120	84
NVS0.9CE-M6	9-36	0.45	3.3	0.9	50	79
NVS0.7CG-M6	9-36	0.55	5.0	0.7	50	81
NVS0.3CH-M6	9-36	0.65	12	0.34	95	82
NVS0.3CJ-M6	9-36	0.65	15	0.28	120	82
NVS0.9EE-M6	18-75	0.33	3.3	0.9	50	80
NVS0.7EG-M6	18-75	0.33	5.0	0.7	50	81
NVS0.3EH-M6	18-75	0.33	12	0.34	95	82
NVS0.3EJ-M6	18-75	0.33	15	0.28	120	82

Continued next page



**NV Series: 4 - 6W DC/DC Converters**  
**9-36V, 18-36V, 36-72V & 16-75V Inputs**  
**3.3V, 5.0V, 12V, 15V, ±5.0V, ±12V, ±15V & ±24V Outputs**

Continued from previous page

Selection Chart – Dual Outputs						
Model	Input voltage, Vdc	Input current, max, Adc	Output voltage, Vdc (Vo)	Output rated current, Adc (Io.Max)	Output ripple and noise, mVp-p	Efficiency, %
NVD01YGG-M6	18-36	0.27	±5.0	±0.50	60	82
NVD0.5YHH-M6	18-36	0.33	±12	±0.25	100	83
NVD0.3YJJ-M6	18-36	0.33	±15	±0.14	120	84
NVD01ZGG-M6	36-75	0.17	±5.0	±0.50	60	82
NVD0.5ZHH-M6	36-75	0.17	±12	±0.25	100	83
NVD0.3ZJJ-M6	36-75	0.17	±15	±0.14	120	84
NVD0.7CGG-M6	9-36	0.65	±5.0	±0.35	50	81
NVD0.3CHH-M6	9-36	0.65	±12	±0.17	95	82
NVD0.3CJJ-M6	9-36	0.65	±15	±0.14	120	82
NVD0.1CKK-M6	9-36	0.65	±24	±0.08	190	83
NVD0.7EGG-M6	18-75	0.33	±5.0	±0.35	50	81
NVD0.3EHH-M6	18-75	0.33	±12	±0.17	95	82
NVD0.3EJJ-M6	18-75	0.33	±15	±0.14	120	82
NVD0.1E KK-M6	18-75	0.33	±24	±0.08	190	83

### Absolute Maximum Ratings

Stresses in excess of the absolute maximum ratings may cause performance degradation, adversely affect long term reliability and cause permanent damage to the converter. Specifications apply over specified input voltage, output load and temperature range, unless otherwise noted.

Parameter	Conditions/Description	Min	Max	Units
Operating CaseTemp. (Tc)	At 100% load	-40	110	°C
Storage Temperature (Ts)		-55	120	°C

### Environmental and Mechanical Specifications

Parameter	Conditions/Description	Min	Nom	Max	Units
Shock	IEC68-2-27			100	g
Sinusoidal Vibration	IEC68-2-6			10	g
Weight				0.4/12	oz/g
Water Washing	Standard process	Yes			N/A
MTBF	Per Bellcore TR-NWT-000332		3,000		kHrs

### Isolation Specifications

Parameter	Conditions/Description	Min	Nom	Max	Units
Insulation Safety Rating	Vin = Vin.Min – Vin.Max	Operational			N/A
Isolation Voltage (Vps)				1,500	Vdc
Isolation Resistance (Rps)		10			MOhm
Isolation Capacitance (Cps)			1,100		pF



**NV Series: 4 - 6W DC/DC Converters**  
**9-36V, 18-36V, 36-72V & 16-75V Inputs**  
**3.3V, 5.0V, 12V, 15V,  $\pm 5.0V$ ,  $\pm 12V$ ,  $\pm 15V$  &  $\pm 24V$  Outputs**

### Input Specifications (9-36V)

Parameter	Conditions/Description	Min	Nom	Max	Units
Input voltage (Vin)	Continuous	9		36	Vdc
Transient Input Voltage (Vint)	Transient, 100ms			40	Vdc
Input Current when Shutdown	Vin.Nom, Iout = 0A		10	20	mAdc
Turn-On Input Voltage 9-36 Vin	Ramping Up, Io.Max	8	8.5	9	Vdc
Turn-Off Input Voltage 9-36 Vin	Ramping Down, Io.Max	8	8.5	9	Vdc
Turn-On Time	To Output Regulation Band Rise Time		250 10	500	ms ms
Input Reflected Ripple Current	Vin.Max, Io.Max			30	mAp-p
Input Capacitance				0.6	$\mu F$
Switching Frequency	Vin.Nom, Io.Max		250		kHz
Temperature Coefficient				0.02	%Vo/°C

### Input Specifications (18-36V)

Parameter	Conditions/Description	Min	Nom	Max	Units
Input voltage (Vin)	Continuous	18		36	Vdc
Transient Input Voltage (Vint)	Transient, 100ms			40	Vdc
Input Current when Shutdown	Vin.Nom, Iout = 0A		10	20	mAdc
Turn-On Input Voltage 9-36 Vin	Ramping Up, Io.Max	16	17	18	Vdc
Turn-Off Input Voltage 9-36 Vin	Ramping Down, Io.Max	16	17	18	Vdc
Turn-On Time	To Output Regulation Band Rise Time		250 10	500	ms ms
Input Reflected Ripple Current	Vin.Max, Io.Max			30	mAp-p
Input Capacitance				0.6	$\mu F$

### Input Specifications (16-75V)

Parameter	Conditions/Description	Min	Nom	Max	Units
Input voltage (Vin)	Continuous	16		75	Vdc
Transient Input Voltage (Vint)	Transient, 100ms			100	Vdc
Input Current when Shutdown	Vin.Nom, Iout = 0A		8	10	mAdc
Turn-On Input Voltage 9-36 Vin	Ramping Up, Io.Max	14	15	16	Vdc
Turn-Off Input Voltage 9-36 Vin	Ramping Down, Io.Max	14	15	16	Vdc
Turn-On Time	To Output Regulation Band Rise Time		250 10	500	ms ms
Input Reflected Ripple Current	Vin.Max, Io.Max			30	mAp-p
Input Capacitance				0.3	$\mu F$

### Input Specifications (36-75V)

Parameter	Conditions/Description	Min	Nom	Max	Units
Input voltage (Vin)	Continuous	36		75	Vdc
Transient Input Voltage (Vint)	Transient, 100ms			100	Vdc
Input Current when Shutdown	Vin.Nom, Iout = 0A		8	10	mAdc
Turn-On Input Voltage 9-36 Vin	Ramping Up, Io.Max	32	34	36	Vdc
Turn-Off Input Voltage 9-36 Vin	Ramping Down, Io.Max	32	34	36	Vdc
Turn-On Time	To Output Regulation Band Rise Time		250 10	500	ms ms
Input Reflected Ripple Current	Vin.Max, Io.Max			30	mAp-p
Input Capacitance				0.3	$\mu F$

**NV Series: 4 - 6W DC/DC Converters**  
**9-36V, 18-36V, 36-72V & 16-75V Inputs**  
**3.3V, 5.0V, 12V, 15V,  $\pm 5.0V$ ,  $\pm 12V$ ,  $\pm 15V$  &  $\pm 24V$  Outputs**

**Output Specifications**

All specifications apply over input voltage, output load and temperature range, unless otherwise noted.

**All Models**

Parameter	Conditions/Description	Min	Nom	Max	Units
Output Voltage Accuracy	Vin.Nom, 50% Io.Max			$\pm 1$	%Vo
Line Regulation	Vin.Min to Vin.Max, 50% Io.Max			$\pm 1$	%Vo
Load Regulation	Vin.Nom, Io.Min to Io.Max 3.3Vo Other Output Voltages			$\pm 3.5$ $\pm 3.0$	%Vo %Vo
Maximum Output Capacitance	Total, for single and dual outputs 3.3Vo 5Vo, $\pm 5Vo$ 12Vo, $\pm 12Vo$ 15Vo, $\pm 12Vo$ $\pm 24Vo$			680 680 150 100 45	$\mu F$ $\mu F$ $\mu F$ $\mu F$ $\mu F$
Dynamic Regulation Peak Deviation Settling Time	50-100% Io.Max load step change to 1% error band			5.0 1.0	%Vo ms
Output Voltage Ripple	Vin.Min to Vin.Max, Io.Min to Io Max, 20MHz Bandwidth 3.3Vo 5Vo, $\pm 5Vo$ 12Vo, $\pm 12Vo$ , $\pm 24Vo$		50 50 0.8	80 80 1	mVp-p mVp-p %Vo p-p
Output Current Limit Threshold	Output Current Limit Threshold	120		200	%Io.Max
Switching Frequency	Vin.Nom, Io.Max		250		KHz
Temperature Coefficient				0.02	%Vo/ $^{\circ}C$

**Typical characteristic curves for single 5V output type**

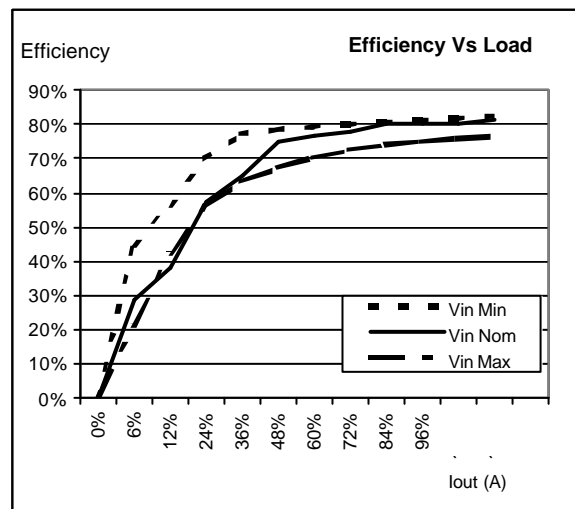
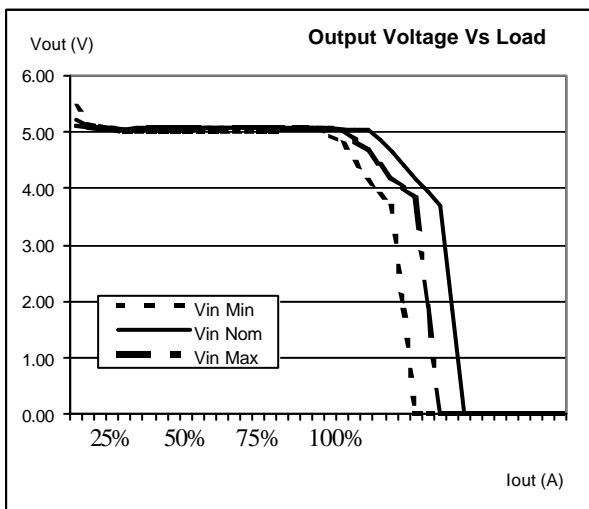

**NV Series: 4 - 6W DC/DC Converters**  
**9-36V, 18-36V, 36-72V & 16-75V Inputs**  
**3.3V, 5.0V, 12V, 15V,  $\pm 5.0V$ ,  $\pm 12V$ ,  $\pm 15V$  &  $\pm 24V$  Outputs**

**Temperature Derating Curves**

The derating curves below give an indication of the output power achievable with and without forced air-cooling. However in the final application the temperature rise of the converter is also influenced by factors such as heat conduction through the leads to the PCB, orientation, the temperature of surrounding components and the input voltage. To ensure the reliability of the converter, care must be taken to guarantee that the maximum case temperature is not exceeded under any conditions. The measurement point for case temperature is specified on the mechanical drawing ( $T_c$ ).

Temperature derating for 18-36V and 36-75V input voltage ranges :

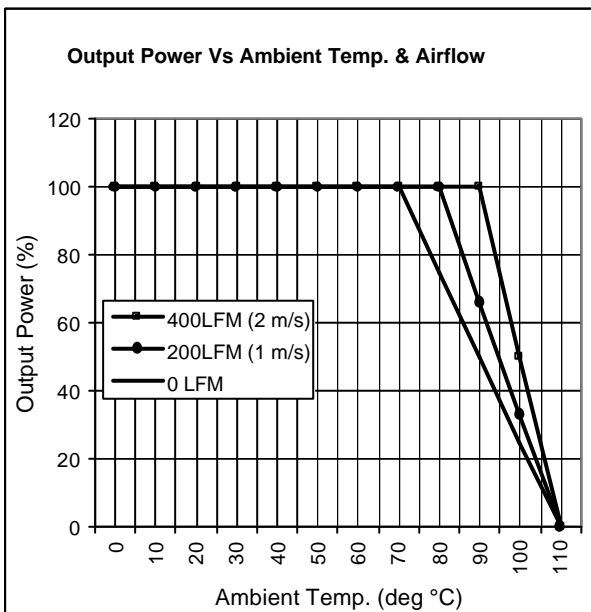

The 9-36V and 18-75V input voltage versions of this series feature a 4:1 input voltage range and can achieve operation at full power at 85°C ambient temperature with only convection cooling.

Temperature derating for 9-36V and 18-75V input voltage ranges :

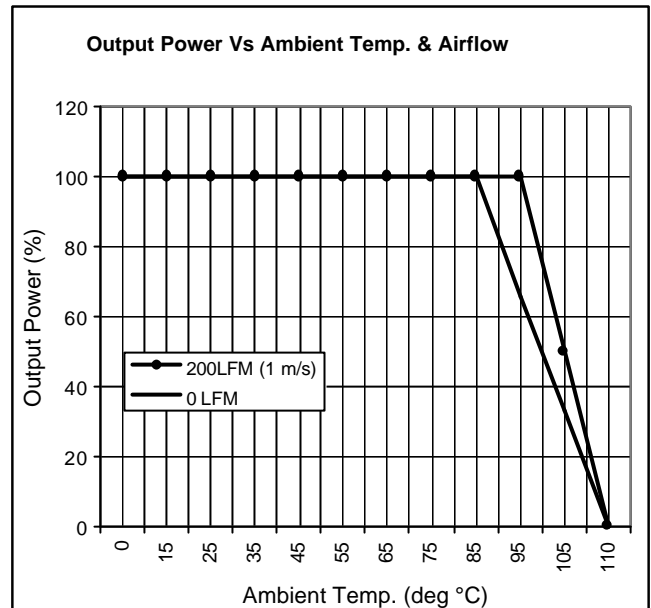

**Typical Application**

This series of converters does not require any external components for proper operation. However, if the distribution of the input voltage to the converter contains significant inductance, a capacitor across the input terminals may be required to stabilize the input voltage. A minimum of 0.47 $\mu F$ , quality electrolytic / ceramic capacitor is recommended for this purpose. For output decoupling it is recommended to connect, directly across the output pins, a 0.47 $\mu F$  ceramic capacitor (for 3.3V and 5V outputs) or a 0.27 $\mu F$  ceramic capacitor (for other outputs). Care must be taken to ensure the maximum rated output capacitance for the device is not exceeded when dimensioning decoupling capacitors in the system as this could cause the unit to detect an overload and enter a 'hiccup' mode of operation.

**NV Series: 4 - 6W DC/DC Converters**  
**9-36V, 18-36V, 36-72V & 16-75V Inputs**  
**3.3V, 5.0V, 12V, 15V,  $\pm 5.0V$ ,  $\pm 12V$ ,  $\pm 15V$  &  $\pm 24V$  Outputs**

### Output Current Limiting

When the output is overloaded above the maximum output current rating, the voltage will start to reduce to maintain the output power to a safe level. In a condition of high overload or short-circuit where the output voltage is pulled below approximately 30% of  $V_{o.Nom}$ , the unit will enter a 'Hiccup' mode of operation. Under this condition the unit will attempt to restart, approximately every 100ms until the overload has cleared.

### Parallel Operation

Paralleling of two converters is possible by direct connection of the output voltage terminal pins. The load regulation characteristic is designed to facilitate current sharing (typically  $\pm 20\%$ ).

### Series Operation

The outputs of two units may be connected in series to achieve a higher system voltage.

### Safety Considerations

These converters feature 1500 Volt DC isolation from input to output. The input to output resistance is greater than 10M $\Omega$ . These converters are provided with Operational Insulation between input and output circuits according to EN60950 / UL1950 / CSA60950-00. Nevertheless, if the system using the converter needs to receive safety agency approval, certain rules must be followed in the design of the system. In particular, all of the creepage and clearance requirements of the end-use safety requirements must be observed. These documents include UL60950, CSA60950-00 and EN60950, although specific applications may have additional requirements.

In order for the output of the converter to be considered as SELV (Safety Extra Low Voltage) or TNV-1, according to EN60950 / UL1950 / CSA60950-00, one of the following requirements must be met in the system design:

- The converter has no internal fuse. An external fuse must be provided to protect the system from catastrophic failure. The recommended fuse values are shown below:

Input Voltage Range	Recommended Fuse
36-75V	F0.315A
18-36V	F0.5A
9-36V	F1.0A
18-75V	F0.5A

- The user can select a lower rating fuse based upon the inrush transient and the maximum input current of the converter, which occurs at the minimum input voltage. Both input traces and the chassis ground trace (if applicable) must be capable of conducting a current of 1.5 times the value of the fuse without opening. The fuse must not be placed in the grounded input line, if any.
- If the voltage source feeding the module is SELV, the output of the converter is considered SELV and may be grounded or ungrounded.
- The circuitry of the converter may generate transients, which exceed the input voltage. Even if the input voltage is SELV (<60V) the components on the primary side of the converter may have to be considered as hazardous. A safety interlock may be needed to prevent the user from accessing the converter while operational.

**NV Series: 4 - 6W DC/DC Converters**  
**9-36V, 18-36V, 36-72V & 16-75V Inputs**  
**3.3V, 5.0V, 12V, 15V, ±5.0V, ±12V, ±15V & ±24V Outputs**

**EMC Specifications**

Conducted Noise:

The converters meet the requirements of EN55022, CISPR22 and FCC CFR title 47 part 15 Sub-part J - Conducted (conducted noise on the input terminals) without any external components. The results for this solution are displayed below.

To meet level B for the above standards it is necessary to fit a 3.3µF ceramic capacitor across the input terminals.

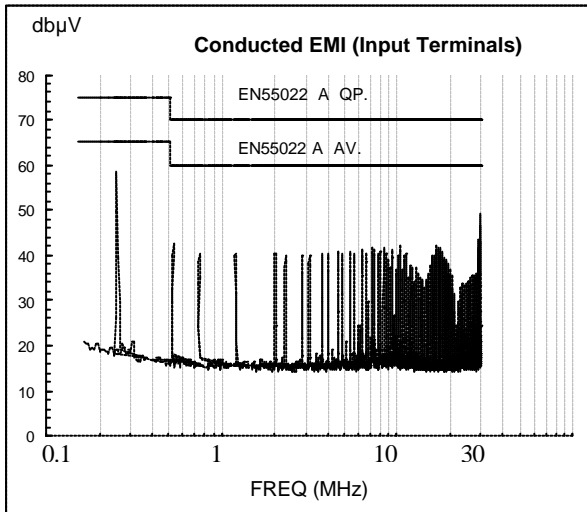

Electromagnetic Susceptibility:

Standard	Applied Stress	Class Level	Performance Outcome *
Electrostatic Discharge EN61000-4-2	2KV to pins	1	B
Electromagnetic Field EN61000-4-3	3V/m	2	A
Electrical Fast Transient EN61000-4-4	2000 Vp to input	3	B
Conducted Disturbances EN61000-4-6	3Vrms to input	2	B

\* **A** denotes normal operation, no deviation from specification. **B** denotes temporary deviation from specification is possible.

**NV Series: 4 - 6W DC/DC Converters**  
**9-36V, 18-36V, 36-72V & 16-75V Inputs**  
**3.3V, 5.0V, 12V, 15V,  $\pm 5.0V$ ,  $\pm 12V$ ,  $\pm 15V$  &  $\pm 24V$  Outputs**

### Surface Mount Assembly

#### Soldering:

The following instructions must be observed when soldering the unit. Failure to observe these instructions may result in failure or significant degradation of the module performance. Power-One will not honor any warranty claims arising from failure to observe these instructions.

This product is approved for forced convection reflow soldering only.

The curves below define the maximum peak reflow temperature permissible measured on Pins 1 and 10 of the converter.

The lead-frame is constructed for a high temperature glass filled, UL94V0 flame retardant, diallyl ortho-phthalate moulding compound commonly used for packaging of electronics components. It has passed NASA outgassing tests and is certified to MIL-M-14. The coefficient of thermal expansion is equivalent to FR4.

The gull wing leads are formed to ensure optimal solder joint strength and structure. Furthermore they facilitate optical inspection (manual or automatic). The leads are formed from a 97% Cu alloy plated with Cu and Sn 90. This material is commonly used in the manufacture of integrated circuits. It has good corrosion resistance and exhibits the nobility inherent to all high copper alloys. Unlike brasses, this material is essentially immune to stress corrosion cracking. It also exhibits excellent solderability. It is readily wetted by solders and performs well in standard solderability tests. (Dip of Class II or better).

The product is manufactured with a patented process, which is fully automated, and 'in-line'. This ensures that there is no contamination or mechanical stress on the lead-frame so that the co-planarity and solderability are maintained.

The product is shipped in JEDEC trays to guarantee preservation of the co-planarity and enable fully automated assembly in the final application.

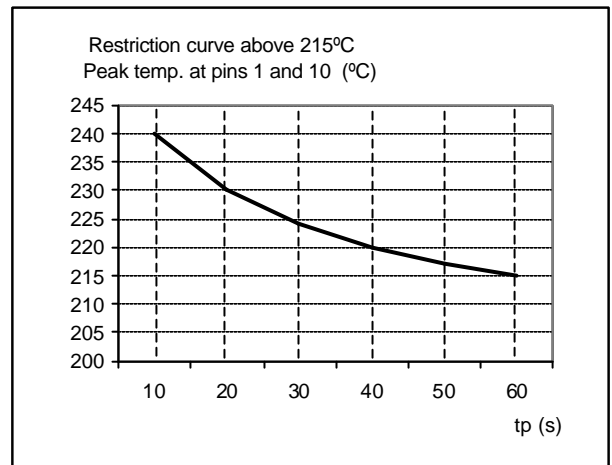
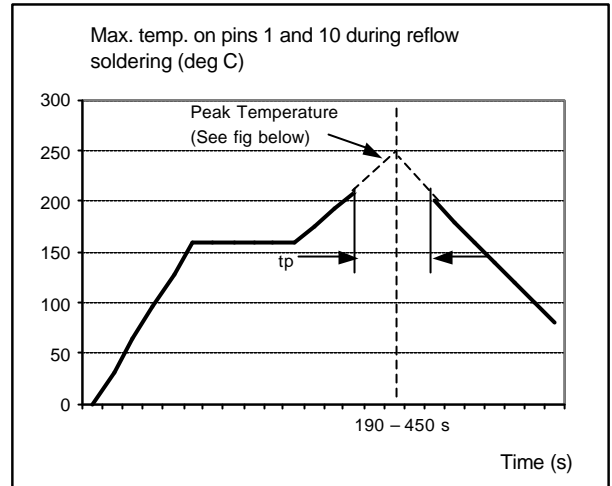

#### Pick & Place Assembly:

The product is designed with a large flat area in the center of the top surface to serve as a pick up point for automated vacuum pick and place equipment. The 'open board' construction of the unit ensures that weight is kept to a minimum. However due to the relatively large size of the component, a large nozzle (> 2.0mm, depending on vacuum pressure) is recommended for picking and placing.

The unit may also be automatically handled using 'odd-form' placement equipment, with mechanical grippers. For this type of equipment the end edges of the device, which have no leads and also feature the greatest dimensional accuracy, should be used as pick-up points.



**NV Series: 4 - 6W DC/DC Converters  
9-36V, 18-36V, 36-72V & 16-75V Inputs  
3.3V, 5.0V, 12V, 15V, ±5.0V, ±12V, ±15V & ±24V Outputs**

**Mechanical Drawing**

Note:- mm[inches]  
Tolerances: -  
**0.5-10 ±0.1**  
**10-100 ±0.2**

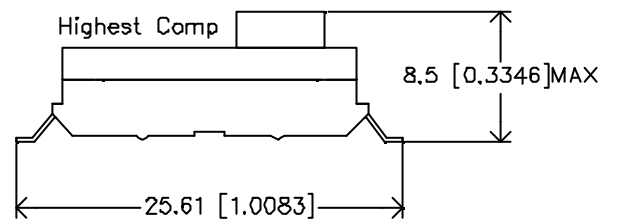
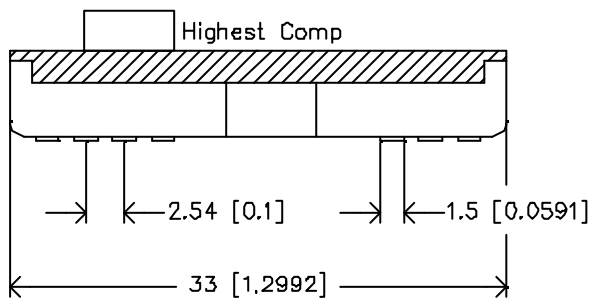
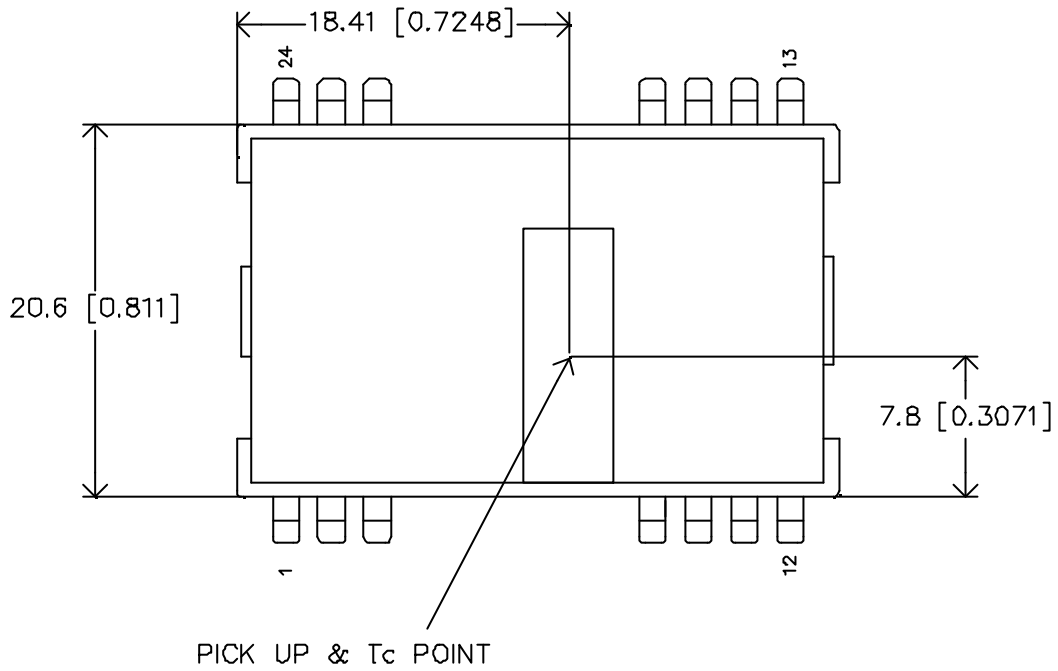

**NV Series: 4 - 6W DC/DC Converters**  
**9-36V, 18-36V, 36-72V & 16-75V Inputs**  
**3.3V, 5.0V, 12V, 15V, ±5.0V, ±12V, ±15V & ±24V Outputs**

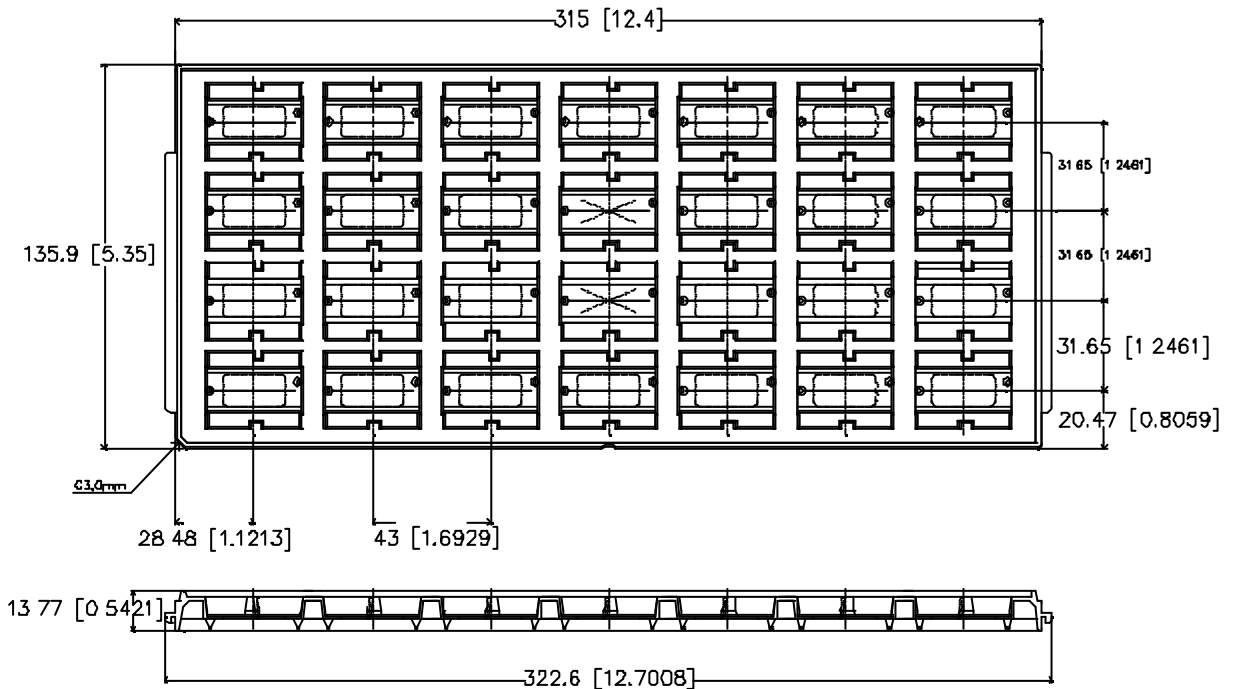
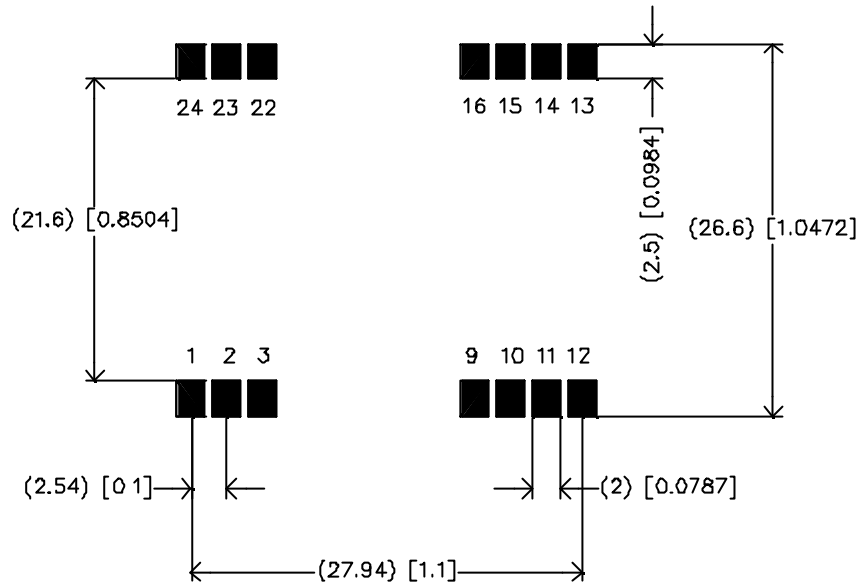

NV Series: 4 - 6W DC/DC Converters  
9-36V, 18-36V, 36-72V & 16-75V Inputs  
3.3V, 5.0V, 12V, 15V,  $\pm 5.0V$ ,  $\pm 12V$ ,  $\pm 15V$  &  $\pm 24V$  Outputs

### Pin-Out

Pin	Function		Reference
	Single Output	Dual Output	
1	+Vin	+Vin	Primary
2	-Vin	-Vin	Primary
3	-Vin	-Vin	Primary
4	No Pin	No Pin	-
5	No Pin	No Pin	-
6	No Pin	No Pin	-
7	No Pin	No Pin	-
8	No Pin	No Pin	-
9	No Connection	No Connection	Secondary
10	No Connection	Vo Return / Common	Secondary
11	No Connection	-Vo	Secondary
12	-Vo	-Vo	Secondary
13	+Vo	-Vo	Secondary
14	No Connection	+Vo	Secondary
15	No Connection	+Vo	Secondary
16	No Connection	Vo Return / Common	Secondary
17	No Pin	No Pin	-
18	No Pin	No Pin	-
19	No Pin	No Pin	-
20	No Pin	No Pin	-
21	No Pin	No Pin	-
22	+Vi	+Vi	Primary
23	+Vi	+Vi	Primary
24	-Vi	-Vi	Primary

### Ordering Information

Options	Suffixes to part number
Surface Mount Version, shipped in JEDEC Tray	Suffix "-M6".
Through hole (lead) version.	Consult factory for availability.

### Notes

1. Consult factory for the complete list of available options.
2. Power-One products are not authorized for use as critical components in life support systems, equipment used in hazardous environments, or nuclear control systems without the express written consent of the President of Power-One, Inc.
3. Specifications are subject to change without notice.